

MC ARMOR



Miguel Caballero



POLICE



S33

LAW
ENFORCEMENT



MC ARMOR

Miguel Caballero®

UNIQUE WORLDWIDE

EXPERIENCE



Bogotá – Colombia

Tel: (+57) 317 566 0706

Correo: contact@miguelcaballero.com



Mexico – DF

Tel: (+52) 782 789 00

Correo: contact@miguelcaballero.com.mx



Miami – USA

Tel: (+1) 786-503 20 95

Correo: contact@mcarmor.com



Santiago de Chile – Chile

Tel: (+56) 9-958 982 16

Correo: mcarmor@miguelcaballero.cl



Brasil

Correo: contact.brasil@miguelcaballero.com

VISIT OUR SITES

www.miguelcaballero.com
www.mcarmor.com





P R O T E C T
AND SERVE



CONTENT



S33®

• CEO MESSAGE	05	• BALLISTIC CERTIFICATION	09
• LAW ENFORCEMENT	06	• SURVIVORS CLUB	11
• PROMISE OF VALUE	07	• GLOBAL PRESENCE	12
• QUALITY CERTIFICATIONS	08		

SOFT ARMOR

• NEW TENDENCE	14
• CONCEALABLE VEST	22
• OUTER BALLISTIC VEST	25

HELMETS

• MICH	45
• PST	46

HARD ARMOR

• PLATE CARRIER	32
• PLATES	39

SHIELDS

• DRF SHIELD IIIA	48
• CONTROL SHIELD III	49
DEFENDER IV	50

CEO'S MESSAGE



MC Armor – Miguel Caballero’s designs, develops and produces ballistic protection solutions, equipping more than 40 police forces around the world. Based on our experience, our corporate mission became to protect the lives of officers who use our products.

Over time our company has developed products in accordance with the needs of users, based on 4 pillars: certified quality, applied design, technology and innovation. Always seeking to guarantee the satisfaction of our customers and exceed their expectations.

LAW ENFORCEMENT



S33 Law Enforcement is a line of products designed and developed according to the highest quality standards. Manufactured with the latest generation materials that offer the user less weight along with greater comfort, safety and confidence.

We seek to preserve the lives of those whom in the police and security forces face multiple risks and threats in order to preserve citizen security and public order during long hours in the performance of their duty.

PROMISE OF VALUE



CERTIFIED QUALITY:

Our production is verified under strict national and international quality controls to guarantee optimum user protection.



DESIGN:

We offer infinite product possibilities, always thinking of the user thanks to a versatile and functional design.



TECHNOLOGY:

We have a research and development department that continuously works with state-of-the-art materials for the development of new products and meeting market needs in an innovative way.



INNOVATION:

The sum of these promises of value in quality, design and technology make our products developed with a highest level of innovation ensuring the absolute satisfaction of each of our users.

QUALITY CERTIFICATIONS



NIJ 0101.06:

In the industry, the companies with the highest levels of quality are subjected to the rigor of the governing body NIJ, which establishes permanent audit parameters. In our company, we have been certified since 2001, which implies permanent audits of our active models.



BA 9000:

The bulletproof vest manufacturer's BA 9000:2016 certification demonstrates that it has quality management processes and procedures incorporated into the design, manufacture and assembly of ballistic protection product development.



BASC:

BASC Certification Version 4-2012 with the scope of design, production, marketing and maintenance of personal protection products, which demonstrates security controls are in place to avoid contamination of cargo with illicit drugs or that there is a relationship with illegal companies.



ISO 9001:

We are certified to this international standard, which promotes the adoption of a process-based approach, where the effectiveness of the quality management system is developed, implemented and improved to increase customer satisfaction by meeting their requirements.



ISO 14001:

We have the ISO 14001:2015 Certification, which guarantees that all our processes are environmentally friendly. As part of Miguel Caballero's service, we guarantee once the useful life of the product is over, we will carry out the final disposal of the protective elements.



ISO 45001:

ISO 45001 is the international standard for occupational safety and health management systems designed to protect workers and visitors from occupational accidents and illnesses.



The ballistic panels have been certified by the highest quality standard for body armor protection in the world: the United States Department of Justice (N.I.J. 0101.06), through tests carried out by the HP White Laboratory. This garment has been designed with the purpose of protecting the life of the wearer when exposed to ballistic threats.

This body armor provides high protection for the most demanding missions.

TESTING PROCEDURES

- Impact distance 5m. (IIA, II, IIIA)
- Ballistic clay No. 1 surface dimensions: 14 x 61 x 61 cm.
- Impact surface temperature (Ballistic Clay No.1) 15C - 30C °
- Number of impacts made on each panel: 6 impacts.
- Minimum space required between each shot: 5cm
- Maximum allowed trauma: 44mm.
- Panels subjected to 10 continuous days of washing cycles.
- Chronographic measurement of the velocity of the projectile.

NIJ STANDARD 0101.06 OF BALLISTIC THREATS

LEVEL	THREAT	SPEED	WEIGHT
IIA	Cal 9mm FMJ RN 40 S&W FMJ	1.225 ft/s - 373 m/s 1.155 ft/s - 352 m/s	124 gr - 8g 180 gr - 11.7 g
II	Cal 9mm FMJ RN .357 Magnum JSP	1.305 ft/s - 398 m/s 1.430 ft/s - 436 m/s	124 gr - 8g 158 gr - 10.2 g
IIIA	.357 SIG FMJ FN .44 Magnum SJHP	1.470 ft/s - 448 m/s 1.430 ft/s - 436 m/s	125 gr - 8.1g 240 gr - 15.6 g
III	7.62 mm NATO FMJ	2.780 ft/s - 847 m/s	147 gr - 9.6g
IV	.30 (30-06) M2 AP	2.880 ft/s - 878 m/s	166 gr - 10.8g

The NIJ standard 0101.07 was released in 2023. It is a revision of National Institute of Justice (NIJ) Standard 0101.06, Ballistic Resistance of Body Armor, published in 2008. It has notable structural changes as well as the introduction of several improvements to test methods and laboratory practices.

Table 1. NIJ HG THREAT LEVELS AND TEST THREAT AMMUNITION

NIJ HG Threat Level	TEST THREAT AMMUNITION	MANUFACTURER & MODEL ID	REFERENCE VELOCITY
NIJ HG1 (Formerly NIJ 0101.06 LEVEL II)	9mm Luger FMJ RN 124 grains	Remington #23558	1305 ft/s (398 m/s)
	.357 Mag JSP 158 grains	Remington #22847	1430 ft/s (436m/s)
NIJ HG2 (Formerly NIJ 0101.06 LEVEL IIIA)	9mm Luger FMJ RN 124 grains	Remington #23558	1470 ft/s (448 m/s)
	.44 MAG JHP 240 grains	Speer #4453 OR #4736	1430 ft/s (236 m/s)

Notes on Table 1: These rounds may be special ordered from speer or purchased from surplus.

NIJ STANDARD 0101.07 OF BALLISTIC THREATS

LEVEL	TEST THREAT AMMUNITION	MANUFACTURER & MODEL ID	REFERENCE VELOCITY
NIJ RF1 (Enhanced version of NIJ 0101.06 Level III)	7.62 X 51mm M80 Ball NATO FMJ Steel Jacket Spire PT BT 149 + 0/-3 grains.	U.S. Military supply or rounds meeting NATO specifications.	2780 ft/s (847 m/s)
	7.62 x 39mm Surrogate test round 120.5 grains	Specifications provided by NIJ	2380 ft/s (725 m/s)
	5.56 mm M193 BT 56 + 0/-2 grains	U.S. Military supply or rounds meeting NATO specifications.	3250 ft/s (990 m/s)
NIJ RF2 (Same as NIJ RF1 plus 5.56mm M855)	7.62 X 51mm M80 Ball NATO FMJ Steel Jacket Spire PT BT 149 + 0/-3 grains.	U.S. Military supply or rounds meeting NATO specifications.	2780 ft/s (847 m/s)
	7.62 x 39mm Surrogate test round 120.5 grains	Specifications provided by NIJ	2380 ft/s (725 m/s)
	5.56 mm M193 BT 56 + 0/-2 grains	U.S. Military supply or rounds meeting NATO specifications.	3250 ft/s (990 m/s)
	5.56 mm M855 BT 61.8 ± 1.5 grains	U.S. Military supply or rounds meeting NATO specifications.	3115 ft/s (950 m/s)
NIJ RF3 (Formerly NIJ 0101.06 LEVEL IV)	30.06 M2 AP FMJ Spire PT AP 165.7 + 0 /-7 grains	U.S. Military supply or rounds meeting NATO specifications.	2880 ft/s (878 m/s)



THE SURVIVORS' CLUB + IOT OFFICIAL CLUB MEMBERS

Our club is focused on gathering and communicating the stories of all those who have survived ballistic threats and accidents while wearing our products.

If your armored product is impacted in the line of duty and your product is damaged, MC-ARMOR Miguel Caballero will replace it free of charge in exchange for your testimony.



GLOBAL PRESENCE







NEW TENDENCE

NEW TENDENCE
NEW TENDENCE

Outer vests based on the panel size of our patented tank top, providing greater ergonomics, flexibility, reduced weight and tailored to user needs.

ION ARMOR

DESCRIPTION

Outer vest designed to optimize weight and flexibility. Made with fabrics featuring thermoregulatory, antibacterial and antistatic properties.



NIJ

Compliant products



FAST RELEASE:
SIMPLE HINGE
BUCKLE

ADJUSTMENT
WITH VELCRO

FAST RELEASE:
DOUBLE
HINGE BUCKLE
ON EACH SIDE
AND ADJUSTMENT
WITH VELCRO
AND ELASTICS



DETAILS IN HIGH
AND LOW RELIEF



TEXTILE VINYL WHITE
REFLECTIVE AND MATTE BLACK

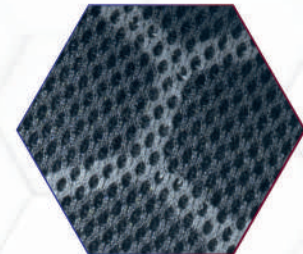

INNER MESH WITH
THERMOREGULATION
PROPERTIES

IRON SIDE

DESCRIPTION

Outer vest with laser-cut MOLLE system, reflective fabric, thermoregulatory, antistatic, and antibacterial inner mesh. Complete 360 protection using removable side panels.



FLEXIBLE PANEL



LIGHTWEIGHT



HIGH RESISTANCE



ANTIBACTERIAL



THERMOREGULATORY

NIJ

Compliant products

SHOULDERS WITH
TENSIONER AND VELCRO
FOR ADJUSTMENT



FRONT AND BACK VELCRO
FOR INSTITUTION'S NAME

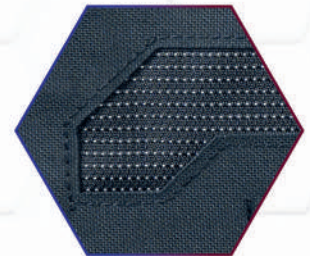

REFLECTIVE FABRIC

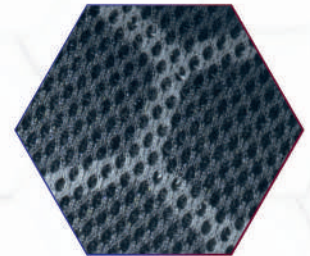

INNER MESH WITH
THERMOREGULATION
PROPERTIES

HIDDEN
ADJUSTMENT FLAPS

FRONT, BACK AND
SIDES LASER CUT
MOLLE SYSTEM.



**INNER MESH WITH
THERMOREGULATING
PROPERTIES**

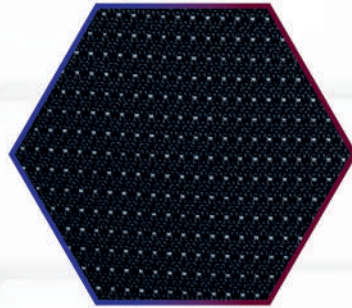

**REFLECTIVE FABRIC
FRONT, BACK AND SIDES**

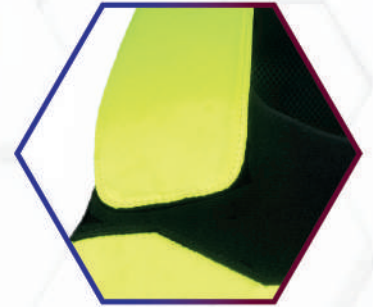

**HIGH-VISIBILITY FABRIC
WITH ANTIFLUID PROPERTIES**



FLECT



DESCRIPTION



High-visibility outer vest with internal thermoregulation materials.
Adjustment flaps to complete 360 protection using removable side panels.



HIGH VISIBILITY



LIGHTWEIGHT



BREATHABLE MESH



ADJUSTABLE



THERMOREGULATORY

SHOULDER
ADJUSTMENT
WITH VELCRO

POLYAMIDE FABRIC

REFLECTIVE FABRIC



NIJ

Compliant products

VELCRO FABRIC

HIGH-VISIBILITY FABRIC



LASER CUT MOLLE SYSTEM

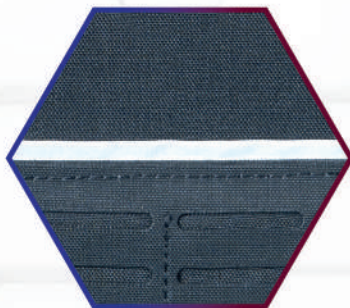

REFLECTIVE FABRIC STRIP

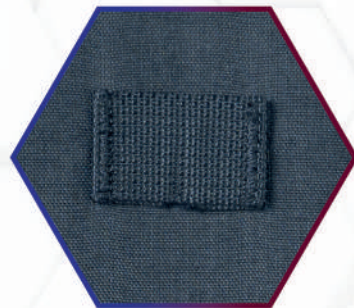

BODYCAM HOLDER



NTG VEST

DESCRIPTION

Outer vest with inner thermoregulating material. Adjusting flaps to complete 360 protection using removable side panels.



HIGH RESISTANCE



LIGHTWEIGHT



BREATHABLE MESH



THERMOREGULATORY



NIJ
Compliant products

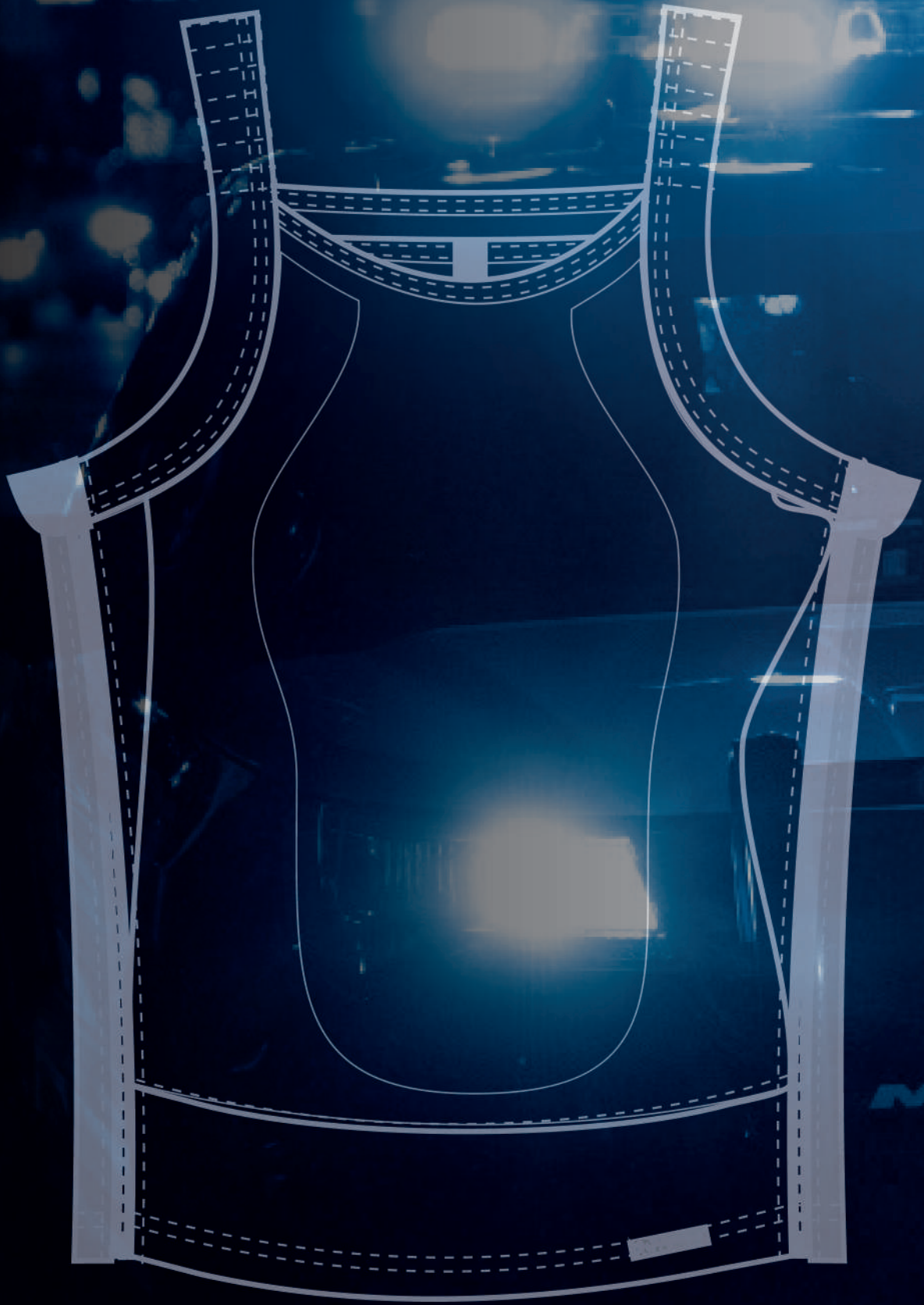

CONCEALABLE VEST

CONCEALABLE VEST
CONCEALABLE VEST

Patented concealable vest lightweight,
flexible, thermoregulatory, and antibacterial,
with certified ballistic protection.

ESTINA

RO POLICE

NEVADA

0697
METRO
POLICE

TANK TOP MILLENIUM

DESCRIPTION

MORE MANEUVERABLE, MORE DISCREET, MORE COMFORTABLE.
Made of flexible materials for a better fit to the body with antibacterial finishes.

 Proactive thermo-regulation system.

 Decreases sweating.

 Hypoallergenic.

 Antimicrobial odor control.

 Better metabolic conservation.



Anti-fragment protection
STANAG 2920
FSP 17-gr



reddot award 2016
winner

NIJ

Compliant products



SIZE: S - XXL
CARRIER WEIGHT: 0.77 Pounds
PANEL WEIGHT: 3.0
REF: 3069

COLORS



BLACK



NAVY
BLUE



GREEN



COYOTE



WHITE

TANK TOP W MILLENIUM

DESCRIPTION

MORE MANEUVERABLE, MORE DISCREET, MORE COMFORTABLE.
Made of flexible materials for a better fit to the body with antibacterial finishes.

- Proactive thermo-regulation system.
- Decreases sweating.
- Hypoallergenic.
- Antimicrobial odor control.
- Better metabolic conservation.



Anti-fragment protection
STANAG 2920
FSP 17-gr



reddot award 2016
winner

NIJ

Compliant products



SIZE: S - XXL
CARRIER WEIGHT: 0.77 Pounds
PANEL WEIGHT: 3.0
REF: 3027

COLORS



BLACK



NAVY
BLUE



GREEN



COYOTE



WHITE



OUTER BALLISTIC VEST

OUTER BALLISTIC VEST
OUTER BALLISTIC VEST

Outer vests designed for the needs of each police force.

STATAL POLICE



DESCRIPTION



FLEXIBLE PANEL



BREATHABLE MESH



HIGH RESISTANCE



ANTIBACTERIAL



THERMOREGULATORY

FAKE CHEST
WITH INTERNAL
ZIPPER

SHIRT-TYPE
VEST

INTERNAL
POCKET FOR
UPPER-LEVEL
PLATE ON
FRONT
AND BACK



DECORATIVE
POCKETS



INTERNAL
THERMOREGULATION
MATERIAL



INTERNAL BELT

ELITE



DESCRIPTION

NIJ
Compliant products



HIGH VISIBILITY



BREATHABLE



HIGH RESISTANCE

RADIO/BODYCAM
HOLDER

SIDE FLAP
ADJUSTMENT
WITH VELCRO

UPPER-LEVEL
PLATE POCKET



SHOULDERS WITH
TENSIONER



MOLLE SYSTEM



HIGH VISIBILITY
EMBROIDERY

PROTEKTOR



DESCRIPTION



FAST RELEASE

RELEASES 4 ANCHORS:
RELEASE ALL BUCKLE IN A SINGLE MOVE



COMFORTABLE



HIGH RESISTANCE

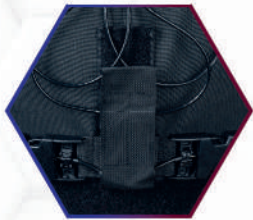

MAIN RELEASE BUCKLE



BUCKLE ADJUSTMENT



ELASTIC ADJUSTMENT FOR
WEIGHT DISTRIBUTION



ACCESORIES HOLDER

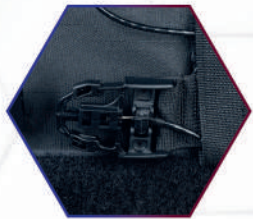

ADJUSTMENT BUCKLES ON
THE ABDOMINAL PART



RIFLE MAGAZINE POCKETS

NIJ

Compliant products

FORTASEG



DESCRIPTION

NIJ

Compliant products



BREATHABLE MESH



ADJUSTABLE



THERMOREGULATORY



VELCRO
ADJUSTMENT
FLAP

SOFT VELCRO FOR
INSTITUTION
EMBROIDERY

SIDES AND
BACK MOLLE
SYSTEM



UPPER-LEVEL
PLATE POCKET



COMPLETE 360 PROTECTION
USING REMOVABLE SIDE PANELS



INTERNAL MESH

DRF

DESCRIPTION

Two removable ballistic panels in front and back covering vital organs.
Strong outer fabric to tearing and tension, antibacterial and deodorizing material with nano technology.



FLEXIBLE PANEL



BREATHABLE MESH



ADJUSTABLE



THERMOREGULATORY

NIJ

Compliant products

FRONT AND BACK
VELCRO FOR
INSTITUTION'S
NAME



UPPER-LEVEL
PLATE POCKET

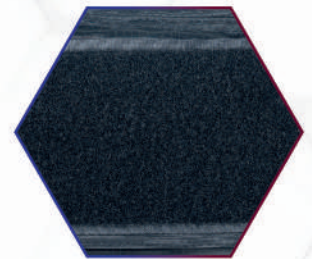
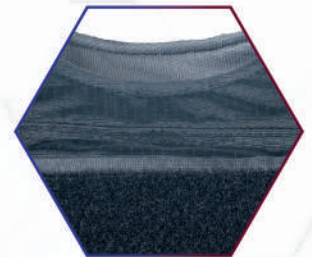

PLATE POCKET FLAP
WITH VELCRO



MOLLE SYSTEM ON FRONT,
BACK, AND SIDES



INTERNAL 3D
ANTIBACTERIAL
MESH WITH
SILVER THREADS

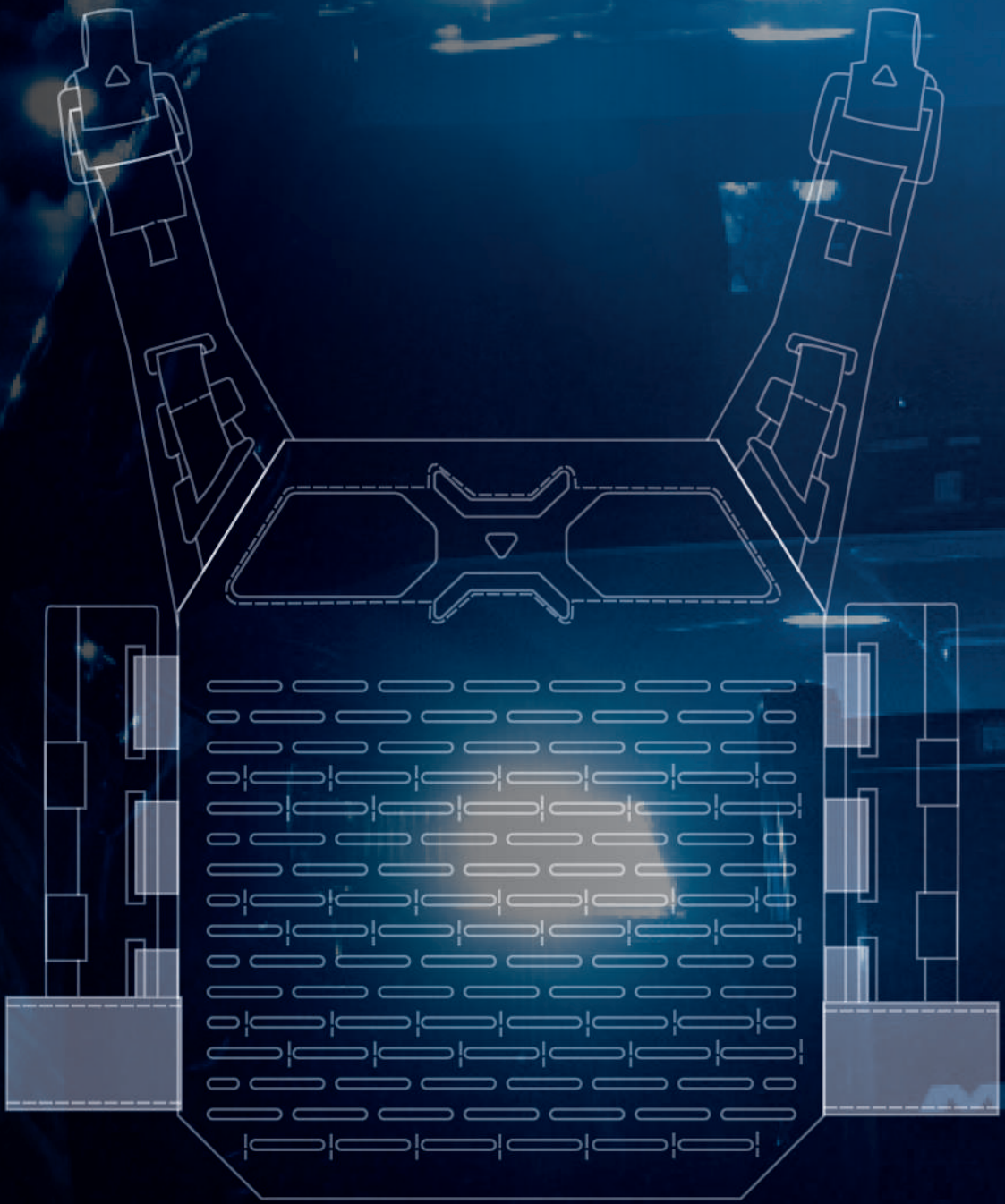

PLATE CARRIER

PLATE CARRIER
PLATE CARRIER

Plate carrier for upper-level protection.

ESTINA

RO POLICE

NEVADA

0697

WOLF



DESCRIPTION



Made of high tenacity Cordura fabric and a compact MOLLE system in laser cut to increase the options for the pouches configuration. MILITARY grade magnetic fast release shoulder and waist release buckles. This plate carrier can be attached to our MC back support to improve comfort and weight distribution.



FLEXIBLE PANEL



LIGHTWEIGHT



BREATHABLE MESH



ADJUSTABLE



COMFORTABLE



THERMOREGULATORY



MOLLE SYSTEM IN FRONT, BACK, AND SIDES

SHOULDER AND SIDE MOUNTED BUCKLES



COLORS



BLACK



GREEN



COYOTE

GRADER



DESCRIPTION



Made of high tenacity Cordura fabric and laser cut Compact MOLLE System to increase the configuration options of the bags. Military grade waistband and quick release magnetic shoulder buckles. Circular Ballistic Protection* (front, side and rear ballistic panel)

* This tactical vest can be attached to our MC backs to improve comfort and weight distribution.



COMFORTABLE
(ELASTIC MATERIAL)



LIGHTWEIGHT



OVERLAP



FLEXIBLE



BALLISTIC RESISTANCE



MOLLE SYSTEM IN FRONT,
BACK, AND SIDES

NIJ

Compliant products

COLORS



BLACK



GREEN



COYOTE

MC BACK

SUPPORT SYSTEM

BASIC

BACK SUPPORT SYSTEM

Our ENTRY LEVEL BACK SUPPORT SYSTEM is a lightweight system that extends the shoulder straps across the shoulders to the chest and connect to a pad.

Full back with shock absorbing pads for added comfort, generating air channels in the back so you can have heat exchange through sweat.

FOR THIS REASON, WE DESIGNED A SUPPORT SYSTEM TO REDUCE AND REDISTRIBUTE THE WEIGHT ON THE BACK.

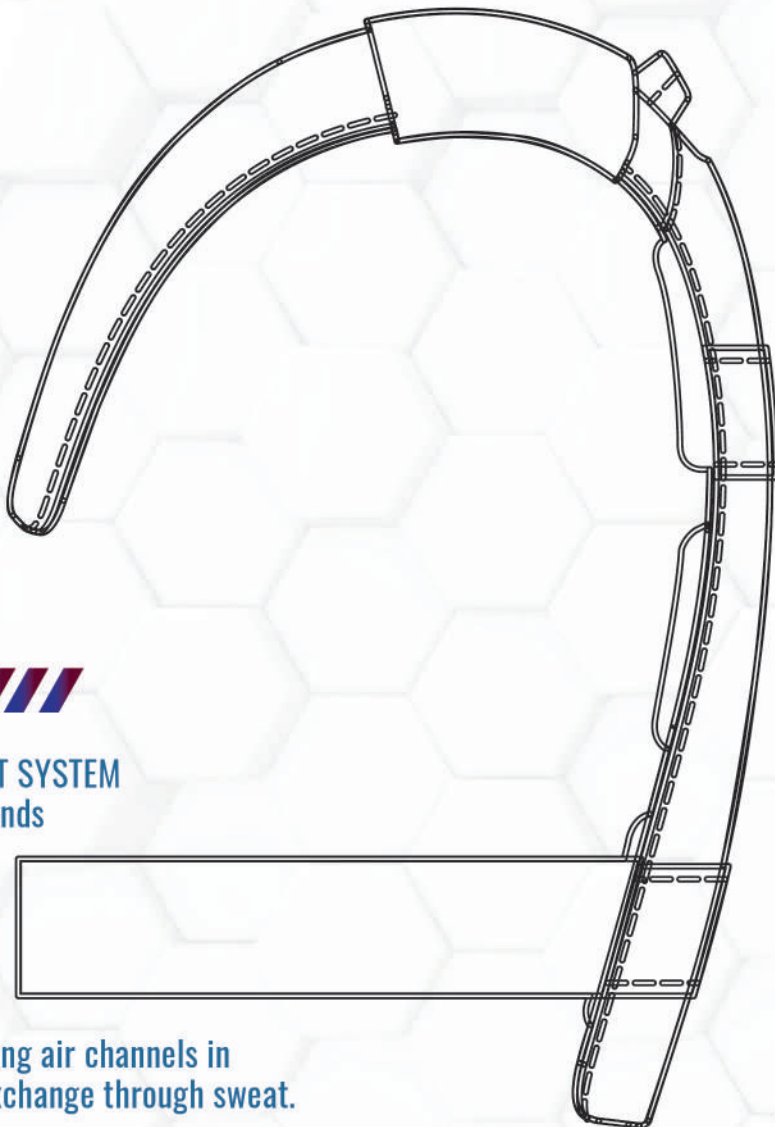

HOW TO USE IT



This infographic shows how our MC back support systems works with the different ballistic vest solutions we offer. Both systems can be combined with each of the Vests, but here we recommended how you will obtain the best performance for your selection.

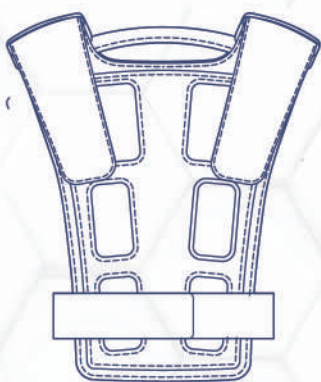

CUSHION
WITH DISTRIBUTION CHANNELS

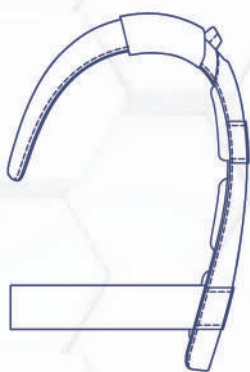

EXTENDED
SHOULDER STRAPS

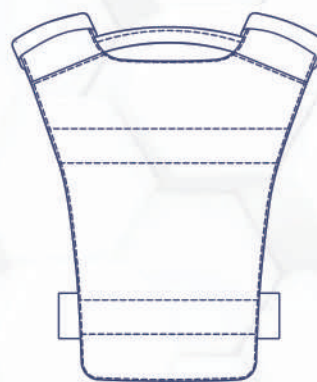

ELASTIC
ADJUSTMENT BAND

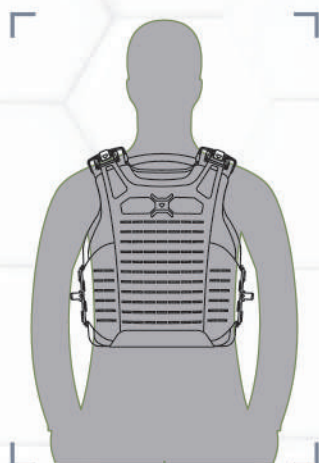

GRADER

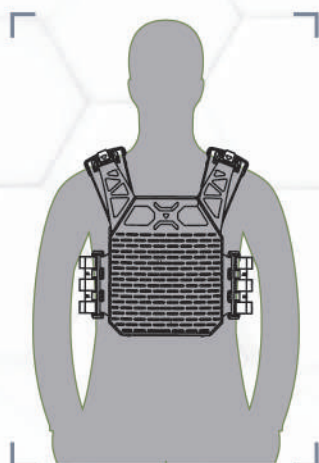

WOLF

CRAWLER



DESCRIPTION



PLATE CARRIER III - IV

Military grade quick release magnetic shoulder with an adjustable pull and straps in laser cut cordura fabric. The configuration and construction of our plate holder allows us to adjust the size of the plate bag (front and back) according to the SAPI size plate.



BREATHABLE MESH



ADJUSTABLE



MADE OF HIGH TENACITY CORDURA FABRIC AND LASER CUT MOLLE SYSTEM

SHOULDER AND SIDE MOUNTED BUCKLES



COLORS



BLACK



NAVY BLUE



GREEN



COYOTE

MC-CARRIER

DESCRIPTION

Made in Cordura fabric made with high tenacity and a compact MOLLE system in laser cut to increase the options for the pouches configuration. This plate carrier can be attached to our MC back support to improve comfort and weight distribution.



BALLISTIC RESISTANCE BELT WITH LATERAL PROTECTION.



BALLISTIC RESISTANCE



NIJ

Compliant products



PLATES

PLATES

MC-III-PLATE



FRONT-BACK



PLATE LEVEL III // MULTI IMPACT



NIJ

Compliant products

BALLISTIC PLATE



100% coated polyester, waterproof, resistant, guaranteeing color fixation throughout its useful life.

NIJ 0101.06

MULTI-IMPACT / 6 SHOTS

STAND ALONE

SINGLE CURVE



KILOGRAMS: 1,5 KG

POUNDS: 3,3 lb

SIZE: 30X25 cm / 10"x12"

[40]

CLASSIC PLATE



BACK



PLATE LEVEL III // MULTI IMPACT

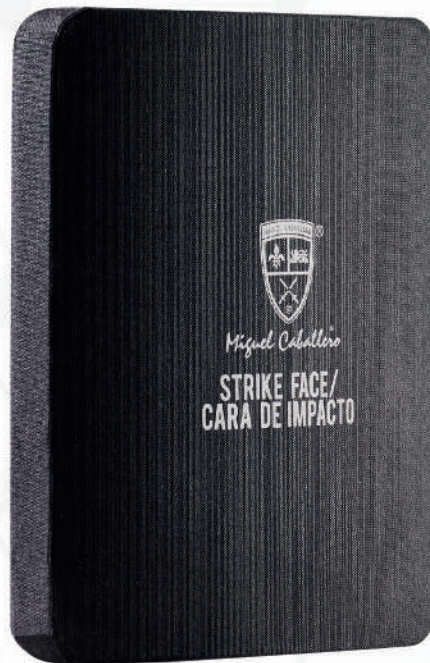

NIJ

Compliant products

BALLISTIC PLATE



100% coated polyester, waterproof, resistant, guaranteeing color fixation throughout its useful life.

NIJ 0101.06

MULTI-IMPACT / 6 SHOTS

STAND ALONE

SINGLE CURVE

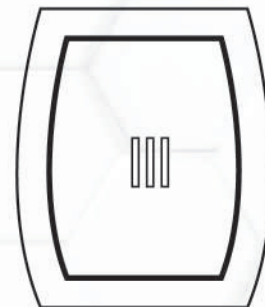

KILOGRAMS: 2 KG

POUNDS: 4,4 lb

SIZE: 30X25 cm/10"x12"



ORION



FRONT-BACK



PLATE LEVEL IV // MULTI IMPACT



NIJ

Compliant products

BALLISTIC PLATE



100% coated polyester, waterproof, resistant, guaranteeing color fixation throughout its useful life.

NIJ 0101.06

MULTI-IMPACT / 3 SHOTS



STAND ALONE



SINGLE CURVE



KILOGRAMS: 2,9 KG



POUNDS: 6,3 lb



SIZE: 30X25 cm/10"x12"



HELMETS

RELLVIE IS
RELLVIE IS



MICH



NIJ 0106.01
HPW TP 0401.01B
STANAG 2920

COLORS



GREEN



COYOTE



BLACK



HARNES ADJUSTMENT SYSTEM

PADS SUSPENSION SYSTEM



SIDE PROTECTION

BUCKLE CLOSURE

PST



NIJ 0106.01
HPW TP 0401.01B
STANAG 2920

COLORS



GREEN



COYOTE



BLACK



HARNES ADJUSTMENT SYSTEM

PADS SUSPENSION SYSTEM



SIDE PROTECTION

BUCKLE CLOSURE

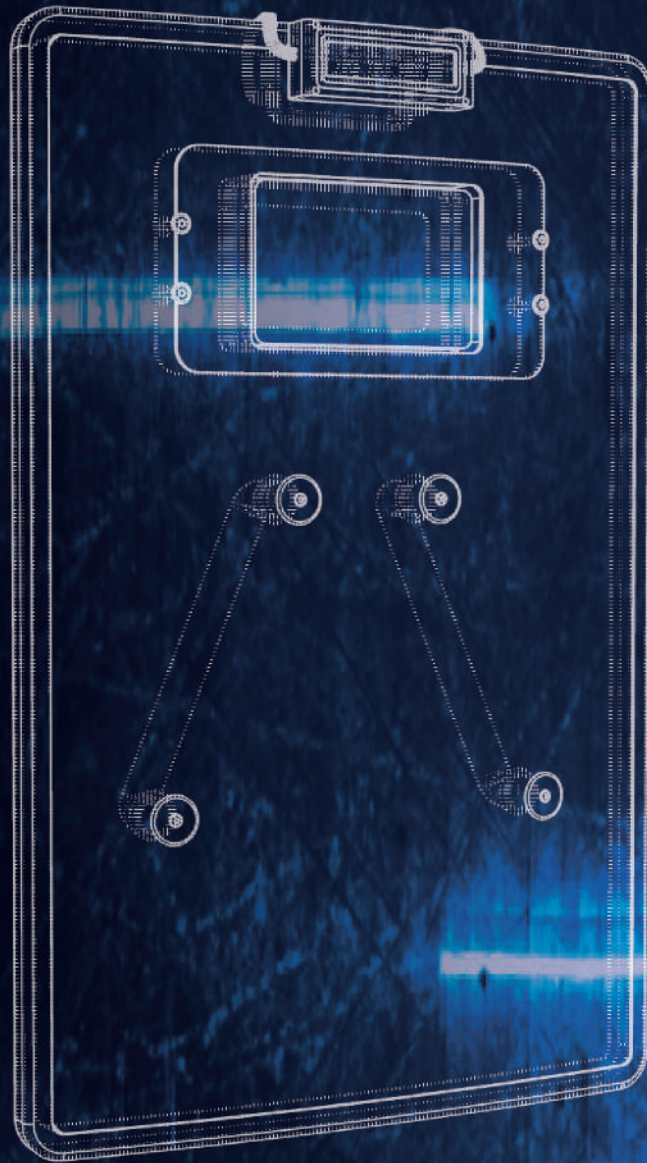

SHIELDS

SHIELDS
SHIELDS

DRF SHIELD IIIA



NIJ 0108.01

BALLISTIC RESISTANCE || || || || || || || ||

WEIGHT // 11 KG || || || || || || || || || ||



AMBIDEXTROUS GRIP



BALLISTIC RESISTANCE

CONTROL SHIELD III



AMBIDEXTROUS GRIP

NIJ 0108.01

53 CM X 90 CM



WEIGHT // 18 KG



AMUNITION: 7,62 X 51 MM - M80

OPTIONAL USE: LIGHTS

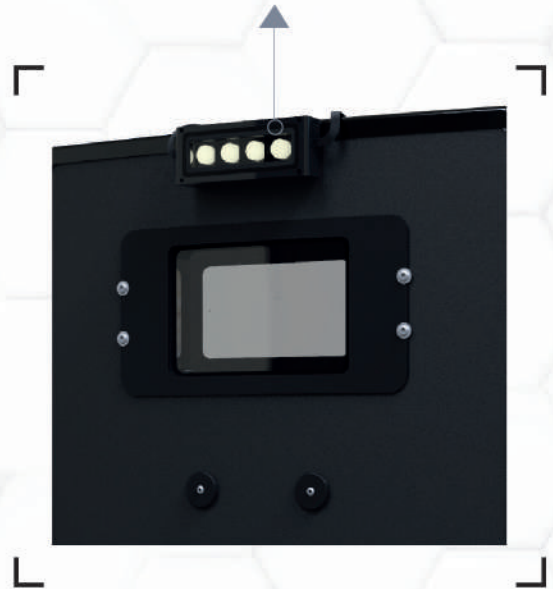

DEFENDER IV

LEVEL IV

NIJ 0108.01

70 CM X 120 CM

WEIGHT // 45 KG

AMUNITION: .30 06 AP M2



TRANSPORT SYSTEM



OPTIONAL USE: LIGHTS

OUR MISSION TO SAVE LIVES



2024 - ALL RIGHTS RESERVED

